

SINERT



SISTEMA
DI GESTIONE
CERTIFICATO
REG. N. 4328 - A
UNI EN ISO 9001-2000



Free Hand



DISPOSITIVI DI SOSTEGNO PER LA SICUREZZA NEL BAGNO

Systems for safety in bathroom





DISPOSITIVI DI SOSTEGNO IN ACCIAIO SMALTATO
per la sicurezza nel bagno
System for safety in the bathroom - enamel steel



MANIGLIONE

Hand bar



COD. DIMENS.

D 2	cm. 30
D 2.1	cm. 40
D 2.2	cm. 50
D 2.3	cm. 60
D 2.4	cm. 90

MANIGLIONE ANGOLARE A 45°

45° angle hand bar

COD. DIMENS.

D 12 cm. 30x30

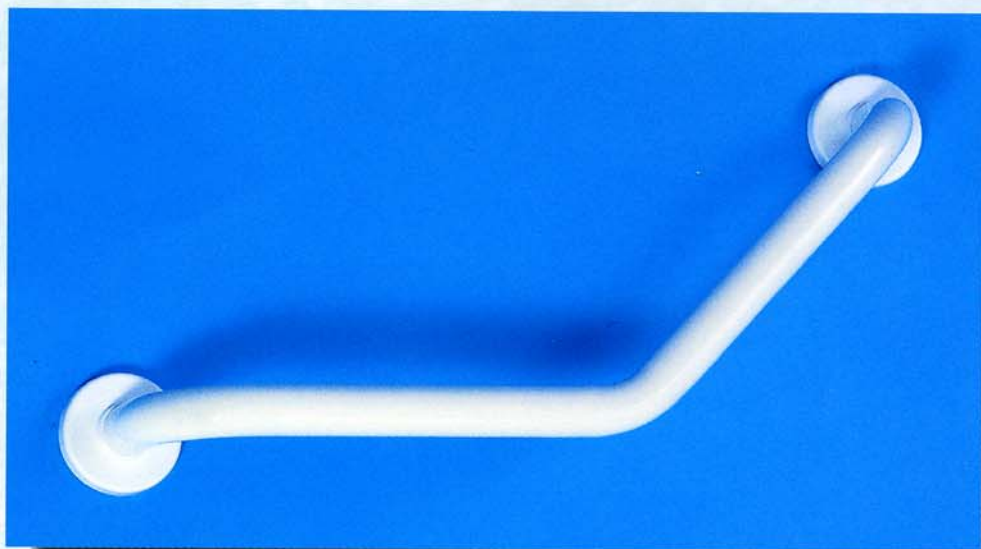

COD. DIMENS.

D 1	cm. 130
D1.1	cm. 150
D1.2	cm. 200

CORRIMANO ORIZZONTALE

Hand bar



CORRIMANO VERTICALE PARETE - PAVIMENTO

Vertical handrail from wall to floor

COD. DIMENS.

D 8 cm. 180

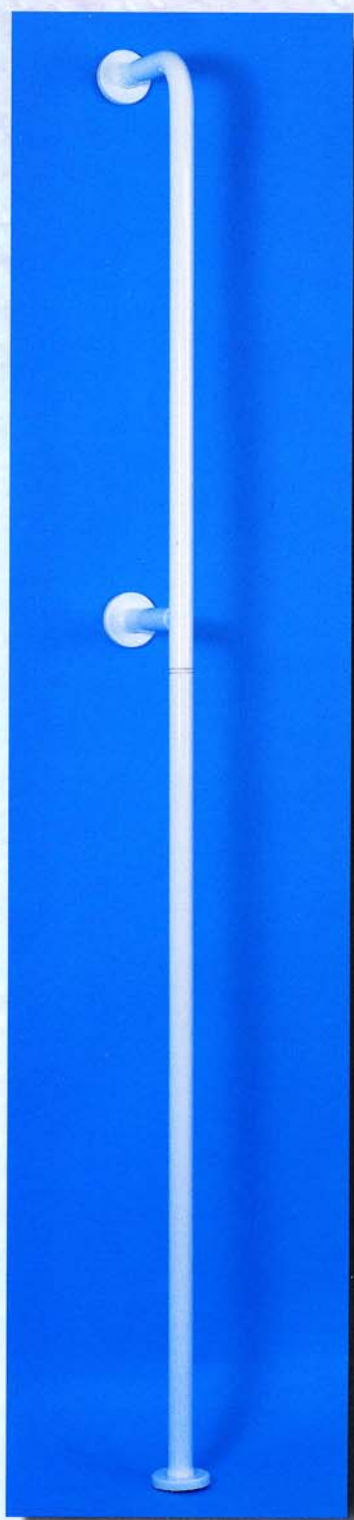

CORRIMANO VERTICALE PARETE - PARETE

Vertical handrail from wall to wall

COD. DIMENS.

D 9 cm. 160

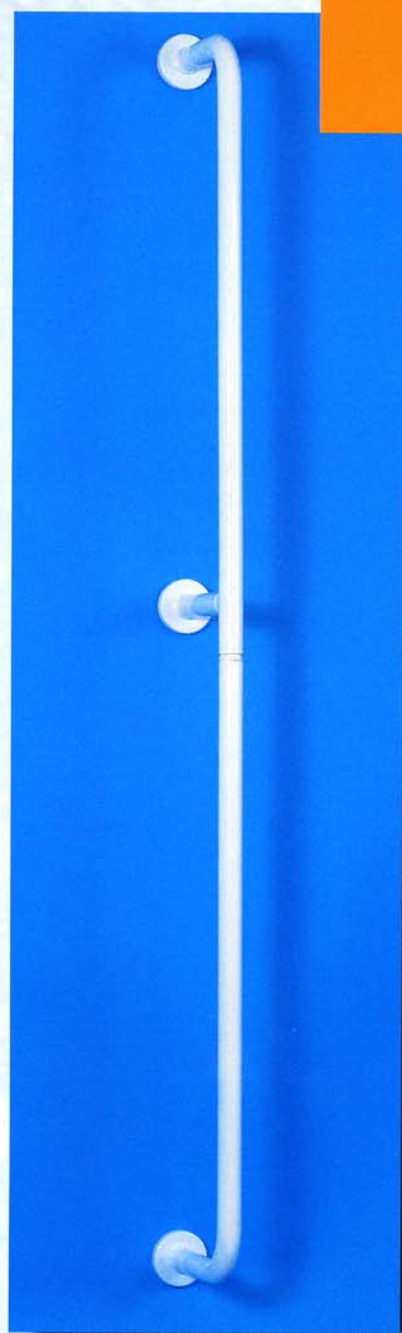

MANIGLIONE ANGOLARE CON MONTANTE DX O SX

angle hand bar with left/right vertical rod

COD. DIMENS.

D 7 cm. 40x70

D 7.1 cm. 66x66



CORRIMANO AD ANGOLO

angle hand rail

COD. DIMENS.

D 5	cm. 70x70
D 5.1	cm. 120x70
D 5.2	cm. 100x100
D 5.3	cm. 120x120

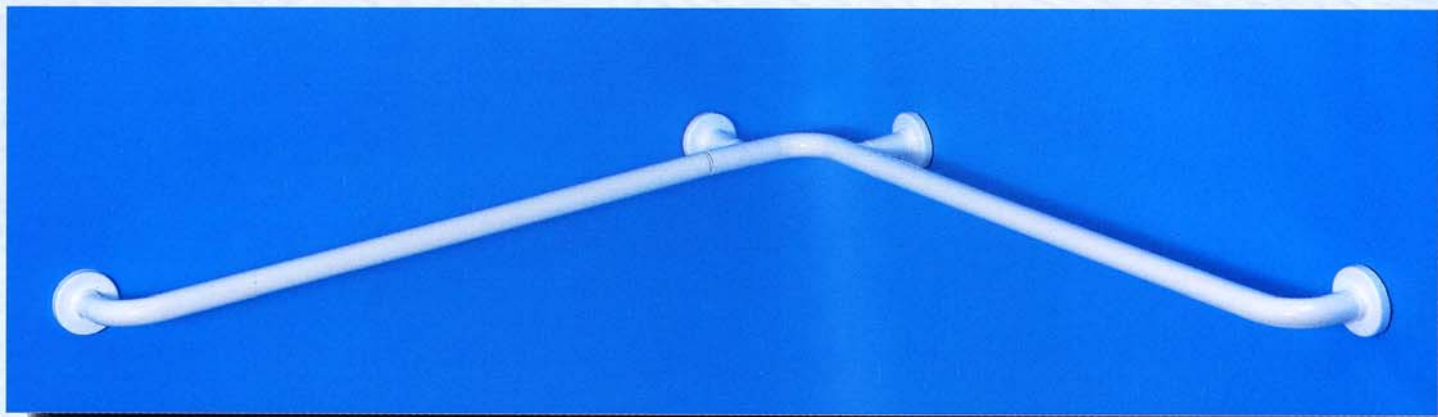

BARRA DI SOSTEGNO CON RINFORZO DX O SX

supporting bar with right or left prop

COD. DIMENS.

D 4 cm. 80

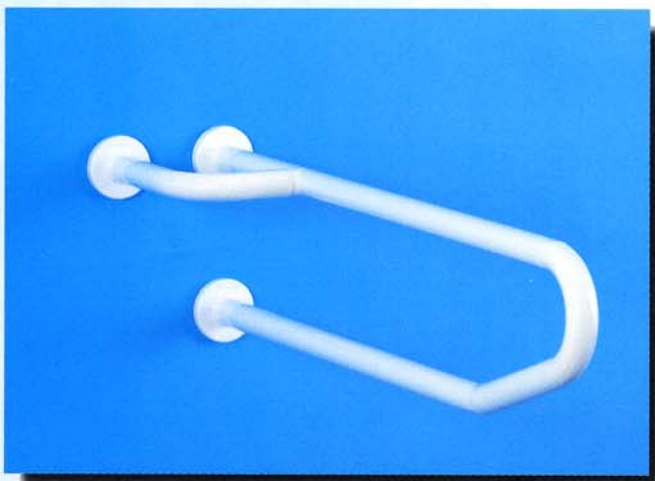

BARRA DI SUPPORTO PARETE/PAVIMENTO CON PIEDE DI RINFORZO DX O SX

wall-to-floor supporting bar

COD. DIMENS.

D 6 cm. 80x80



BARRA DI SOSTEGNO RIBALTABILE

Folding supporting bar



COD. DIMENS.

D 3 Ribaltabile cm. 80

**D 3.1 Ribaltabile cm. 80
con porta rotolo**

SEDILE RIBALTABILE PER DOCCIA

Folding seat for the shower

COD.

**D 11 Seggiolino ribaltabile
asportabile**

**D 11.1 Seggiolino ribaltabile
fisso**



STAFFA PNEUMATICA DI FISSAGGIO LAVABO

Fixing brackets washbasin pneumatic

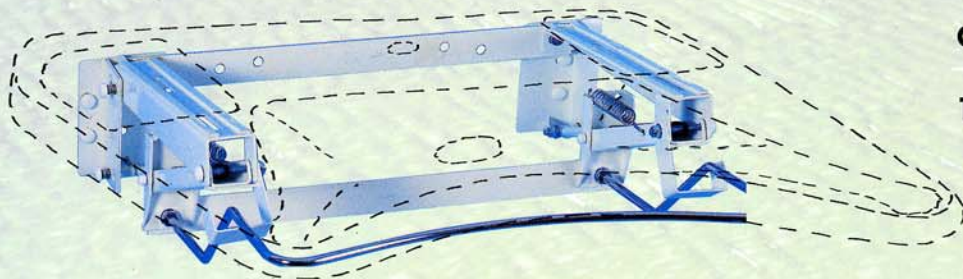

COD.

162

**Staffa con regolazione
pneumatica**

STAFFA FISSA DI FISSAGGIO LAVABO

Fixing brackets washbasin fix

COD.

160

**Staffa fissa
per lavabo**

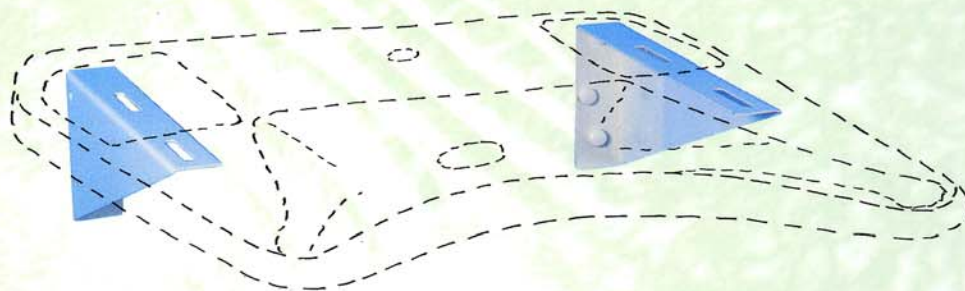

STAFFA MANUALE DI FISSAGGIO LAVABO

Fixing brackets washbasin manual

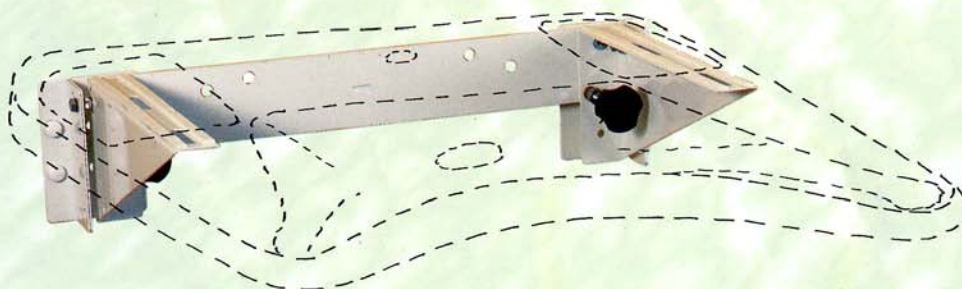

COD.

161

**Staffa con regolazione
a manopola**

SPECCHIO ORIENTABILE

Adjustable mirror

COD.

D 10 cm. 57x50



COPRIBORDO IN TERMOFORMATO PER WC DISABILI

Removable plastic toilet seat for WC disable

COD.

CBDIS Copribordo per
WC disabili



PIATTO DOCCIA FILO PAVIMENTO

Shower tray

COD.

P 1 DIS Piatto doccia 80x80

P 2 DIS Piatto doccia 90x90

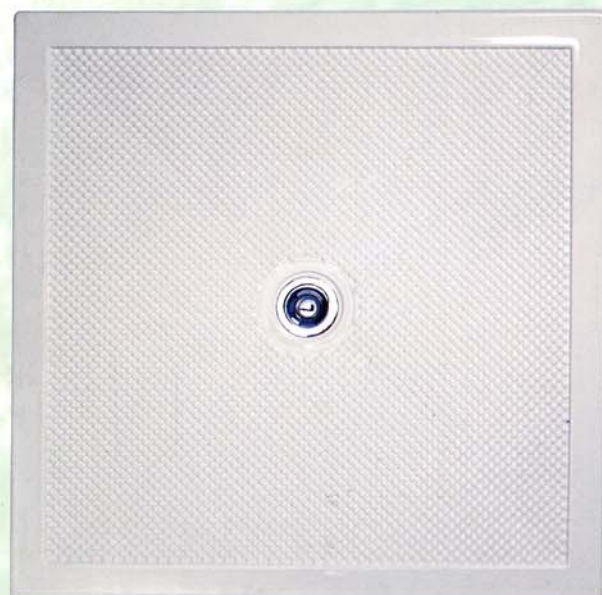

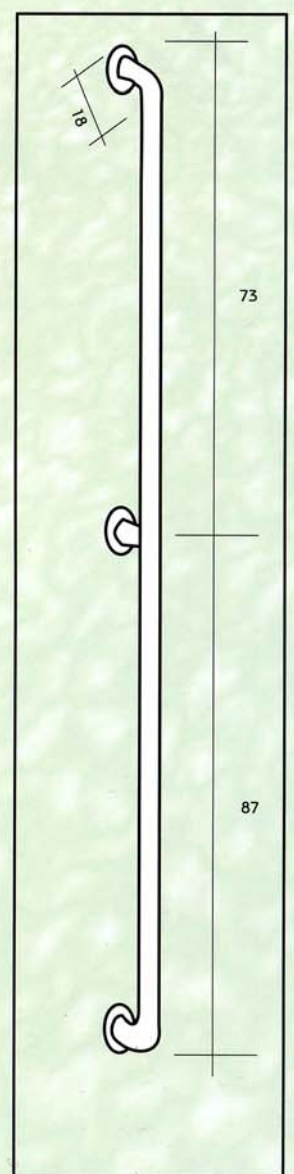
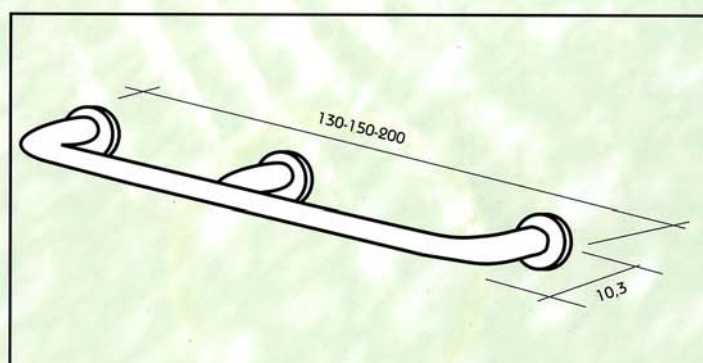
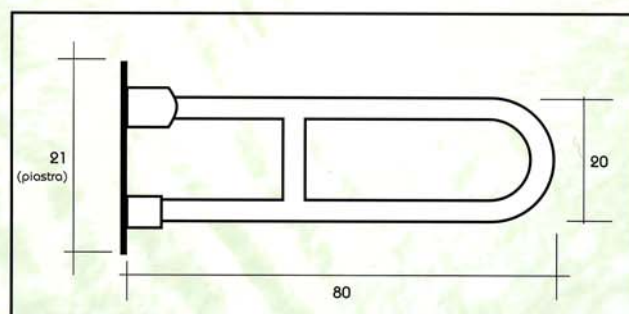
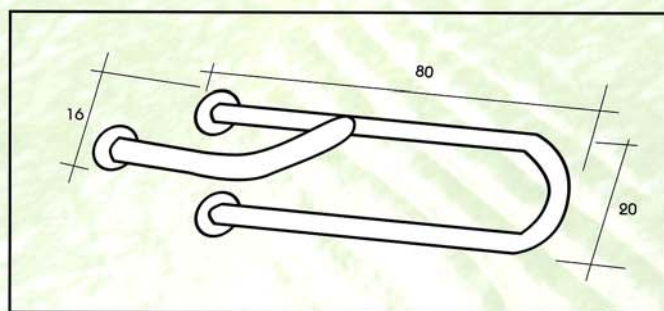
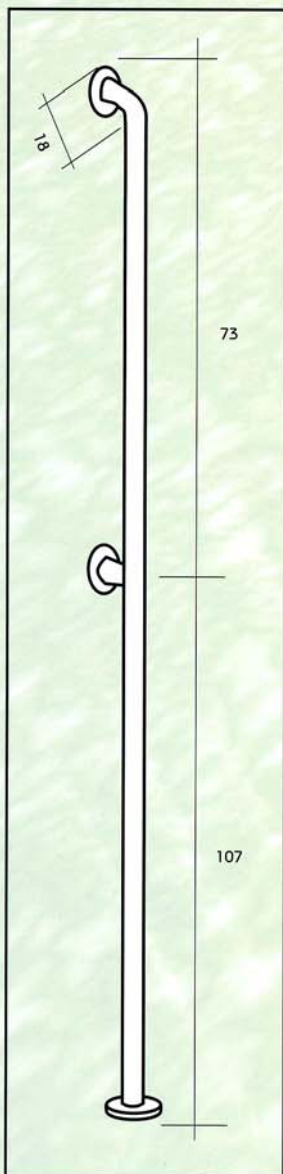
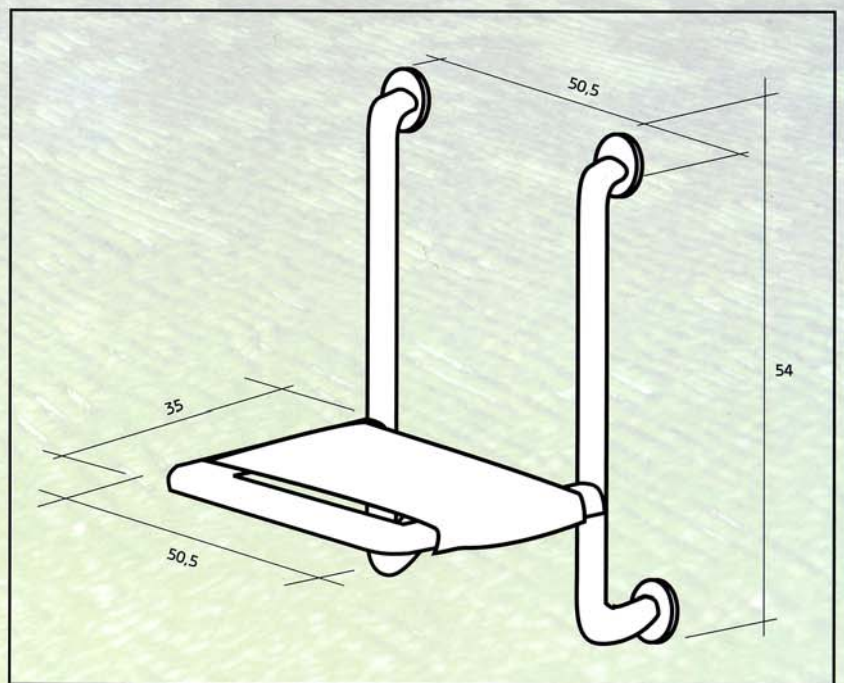
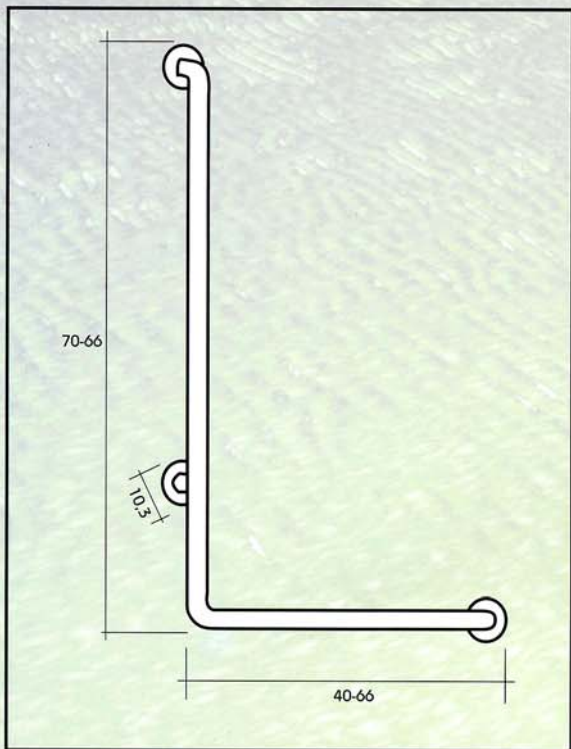

I dispositivi di sostegno della versione in nylon possono essere realizzati anche su misura.

